

Smooth Virtual Part Augen
mit definierter Kraft

Smooth Virtual Part
Schraublöcher fixiert

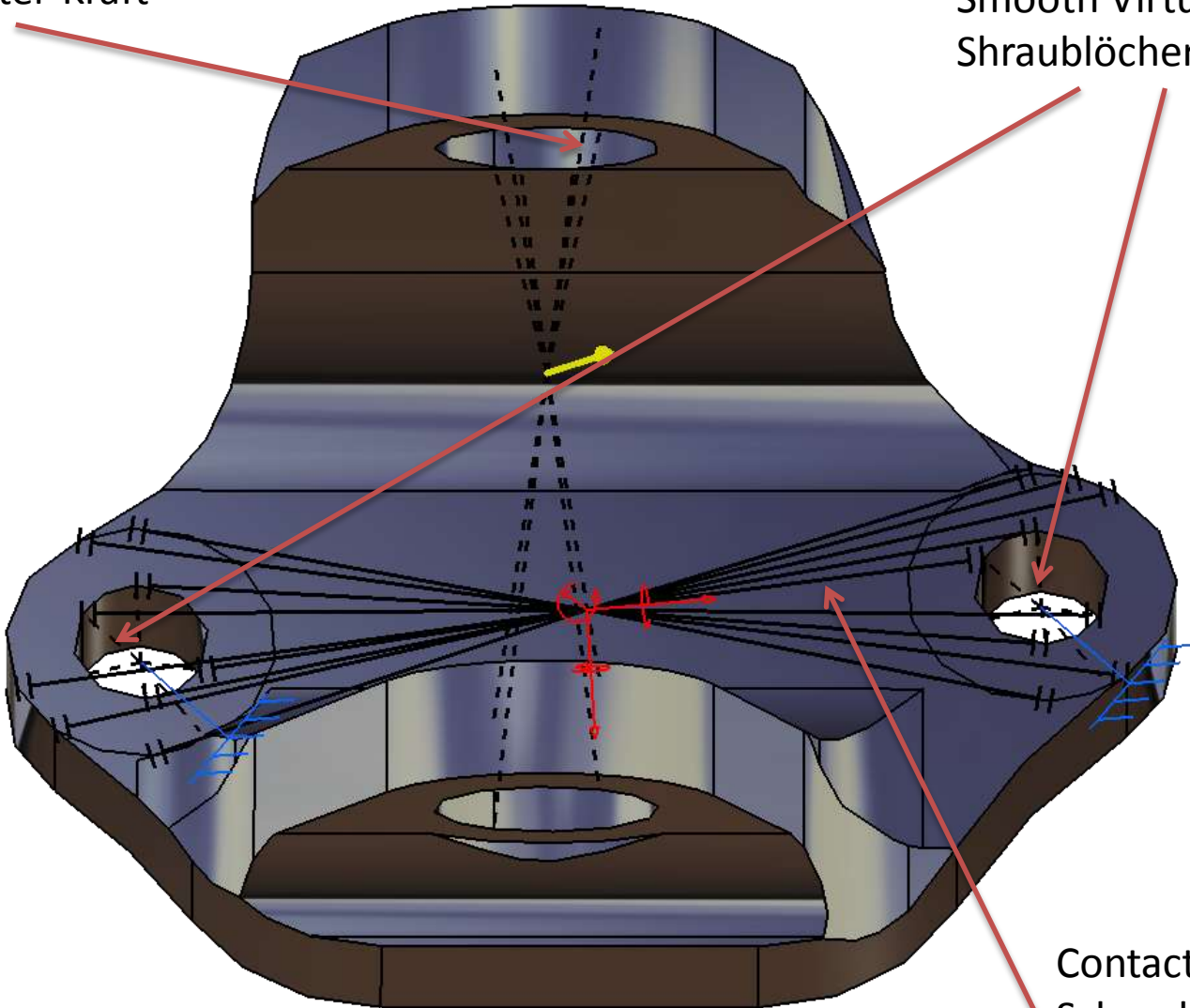

Contact Virtual Part
Schraubkopfauflagen
fixiert

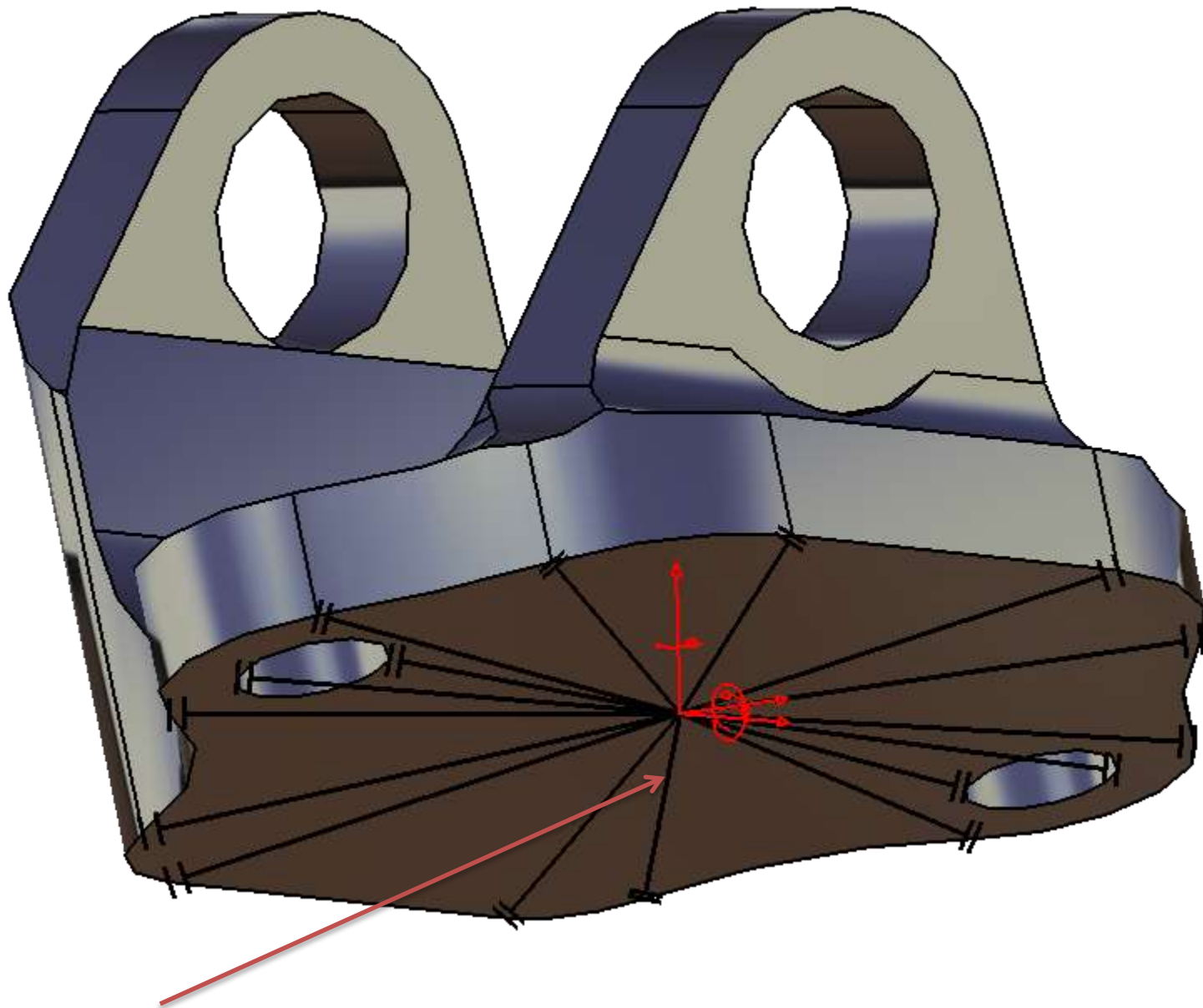

Smooth Virtual Part am Boden
fixiert (Auflage am Gegenstück)

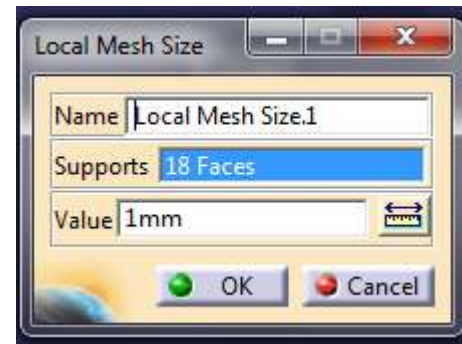
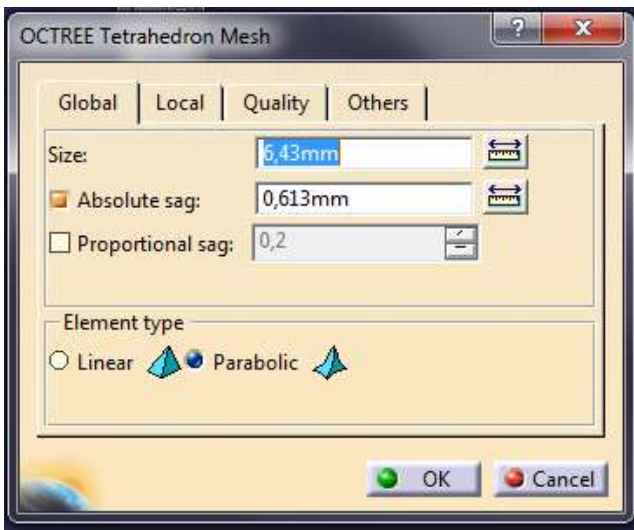

An den angrenzenden
Flächen der
Schraubenbohrungen
und der Augen

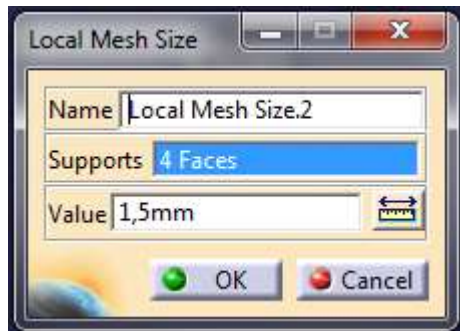

In den Augen

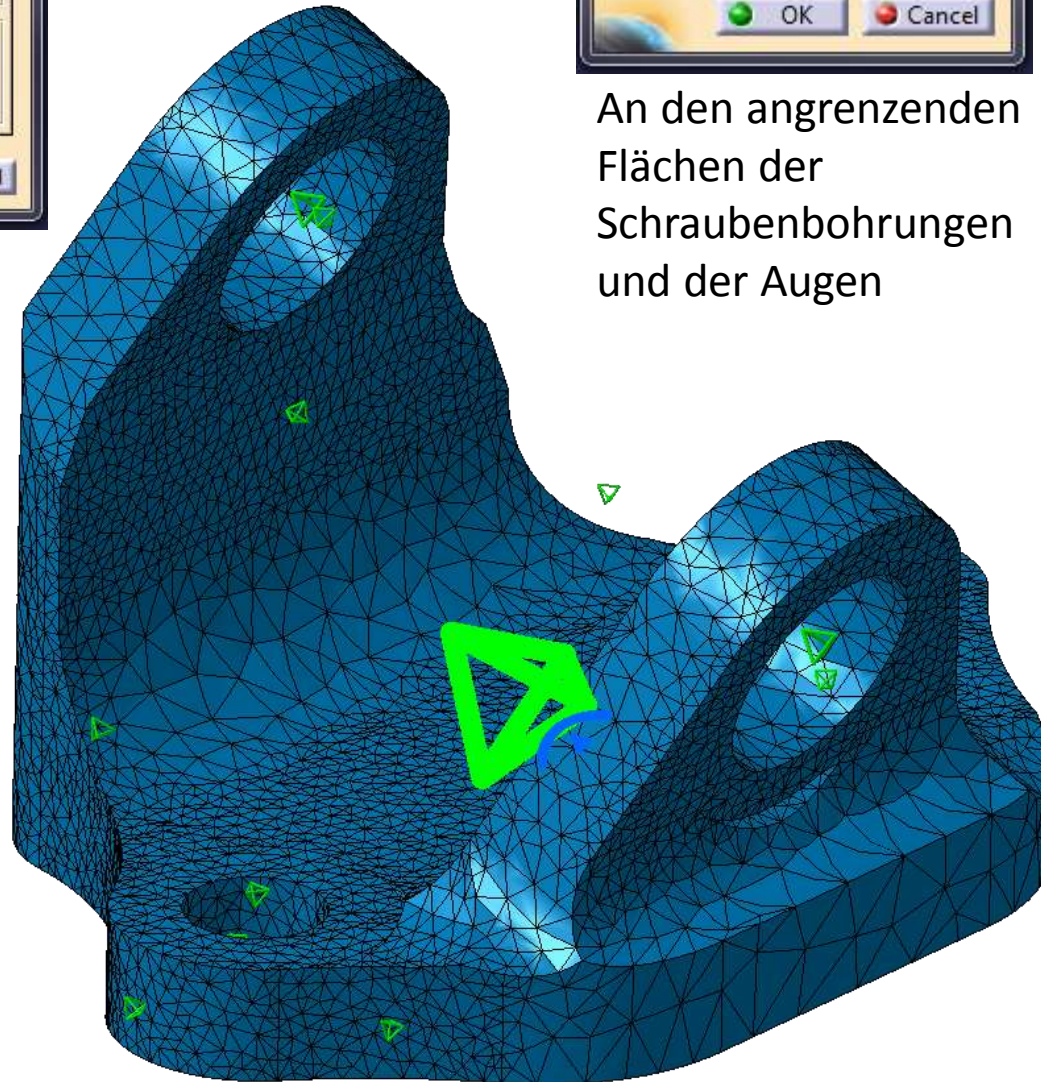

Properties

Current selection : Aluminium

Rendering | Inheritance | Feature Properties | Analysis | Cor

Material: Isotropic Material

Structural Properties

Young Modulus: 70000MPa

Poisson Ratio: 0,346

Density: 2710kg_m3

Thermal Expansion: 2,36e-005_Kdeg

Yield Strength: 485MPa

Info: Other material properties may be loaded using Edit Properties/More item

OK Apply Cancel Help

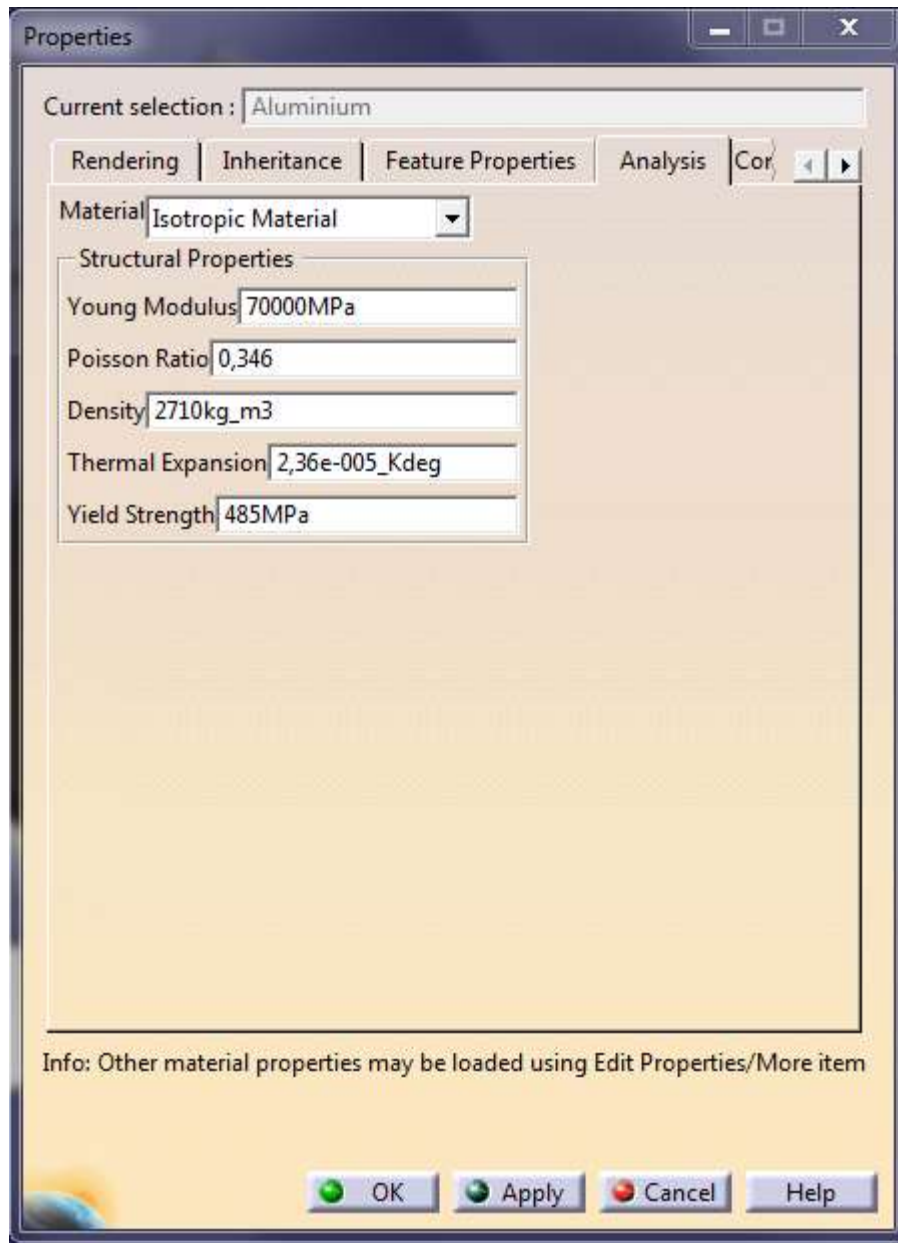

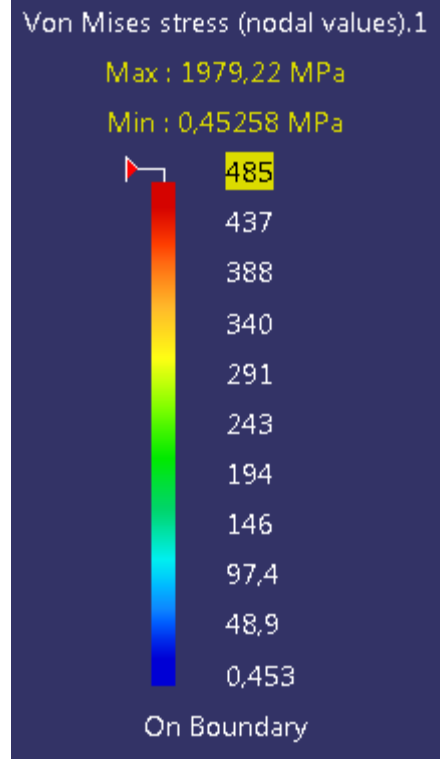
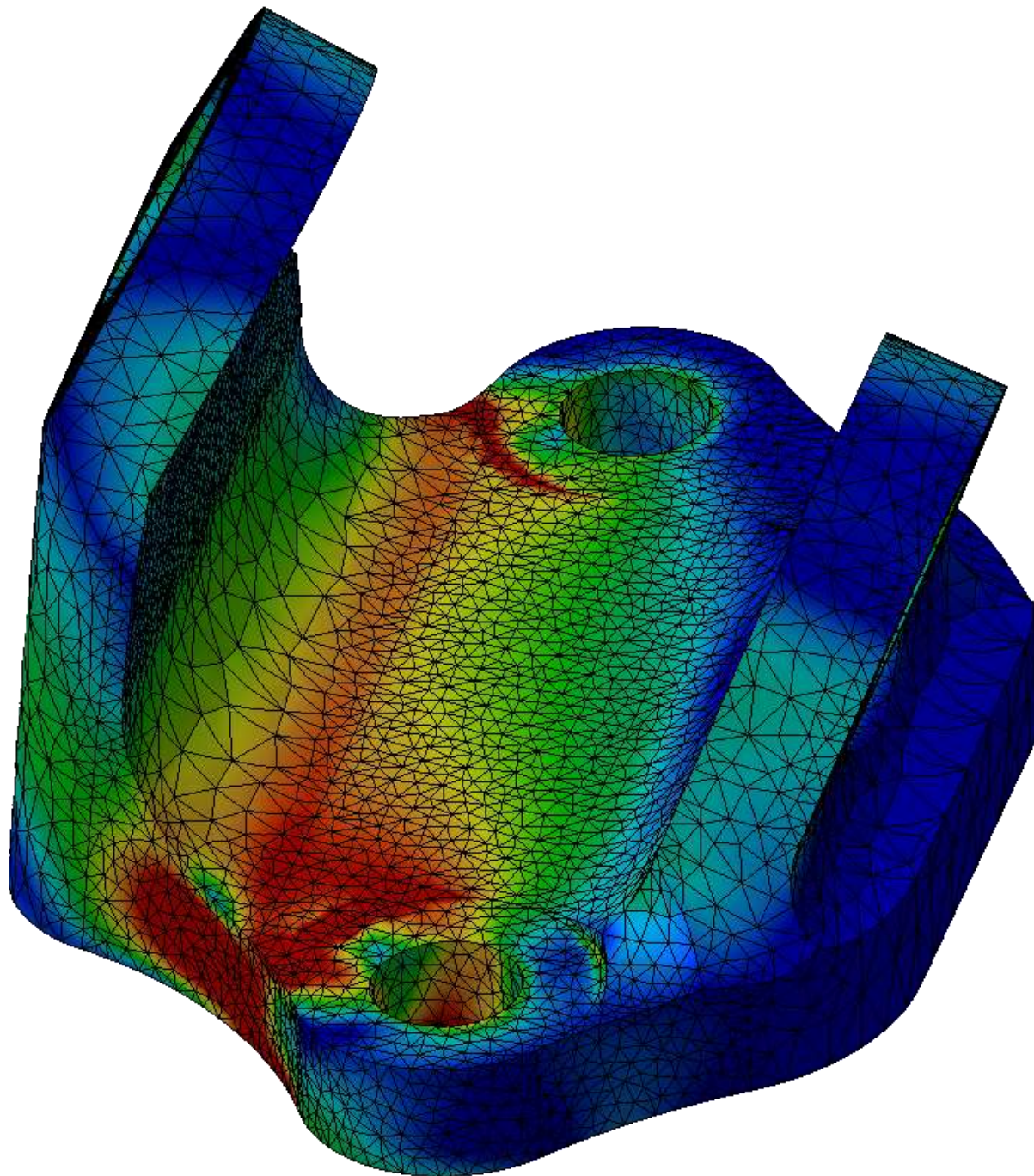

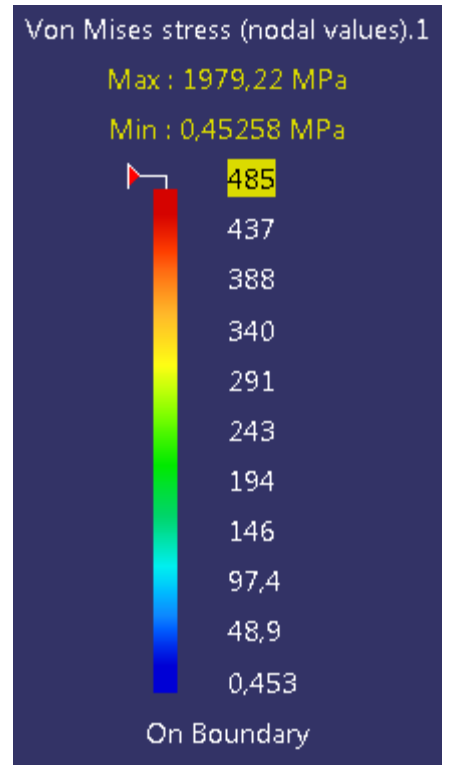
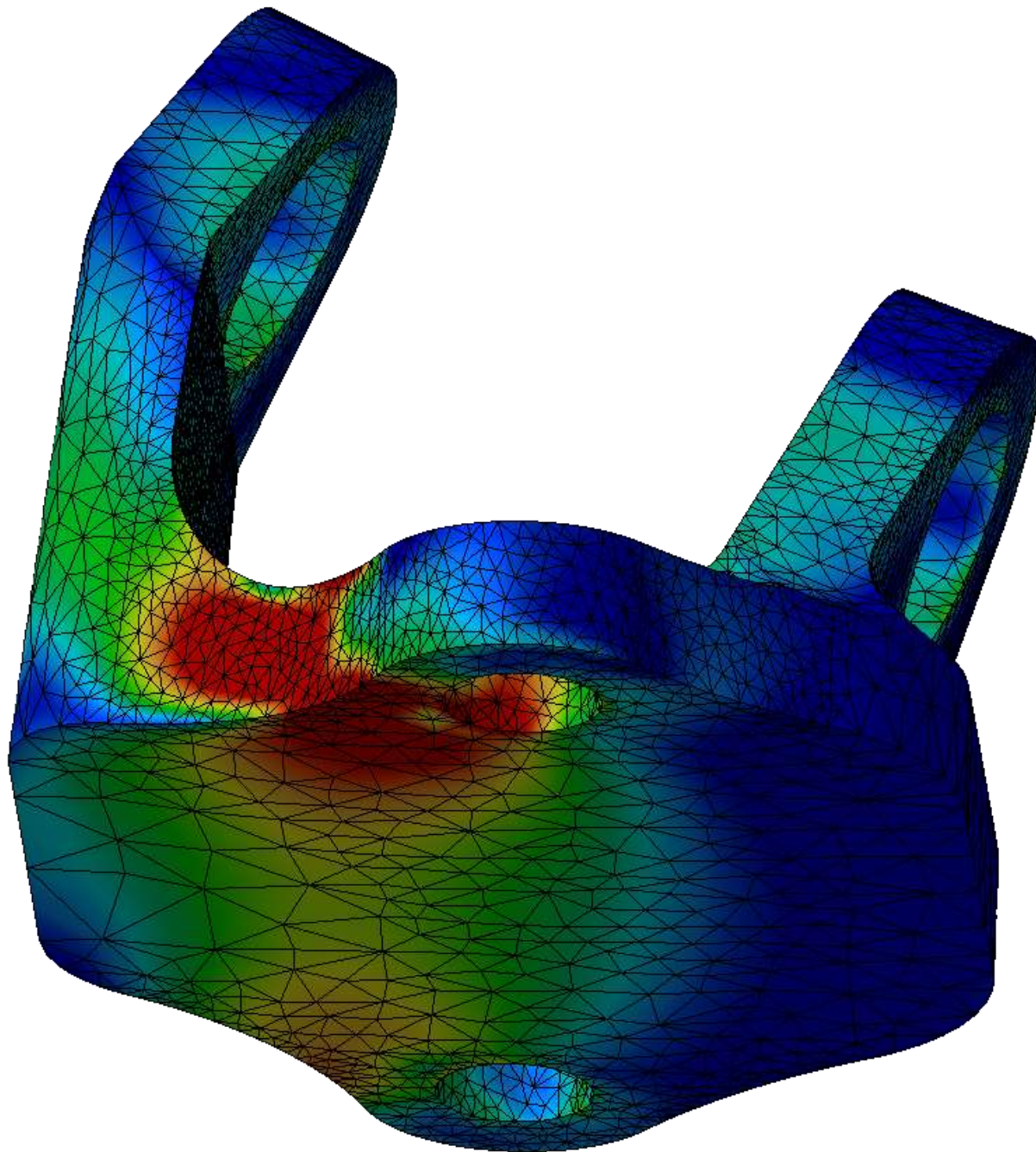

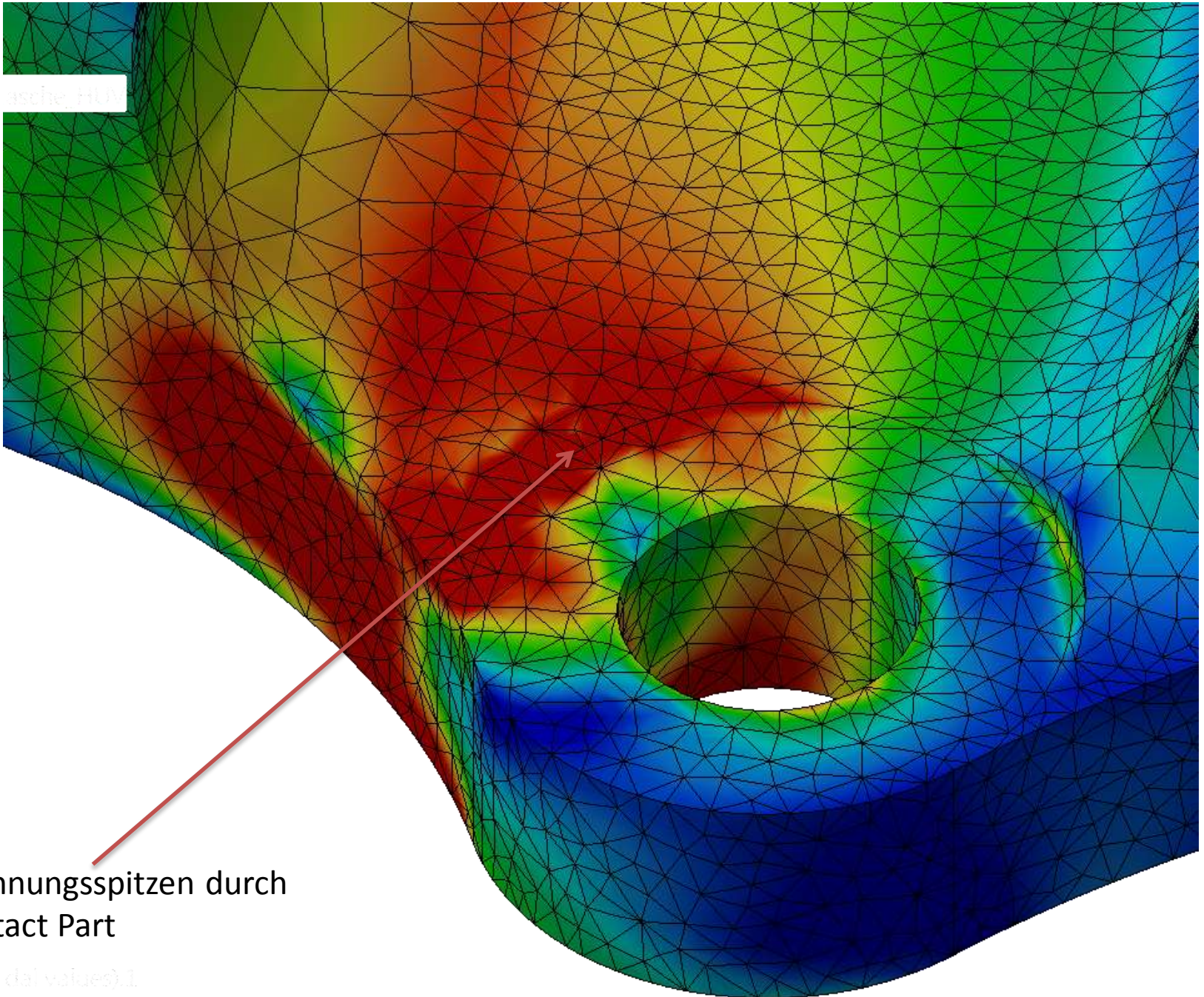

siehe HU

Spannungsspitzen durch
Contact Part

(dof value) 1

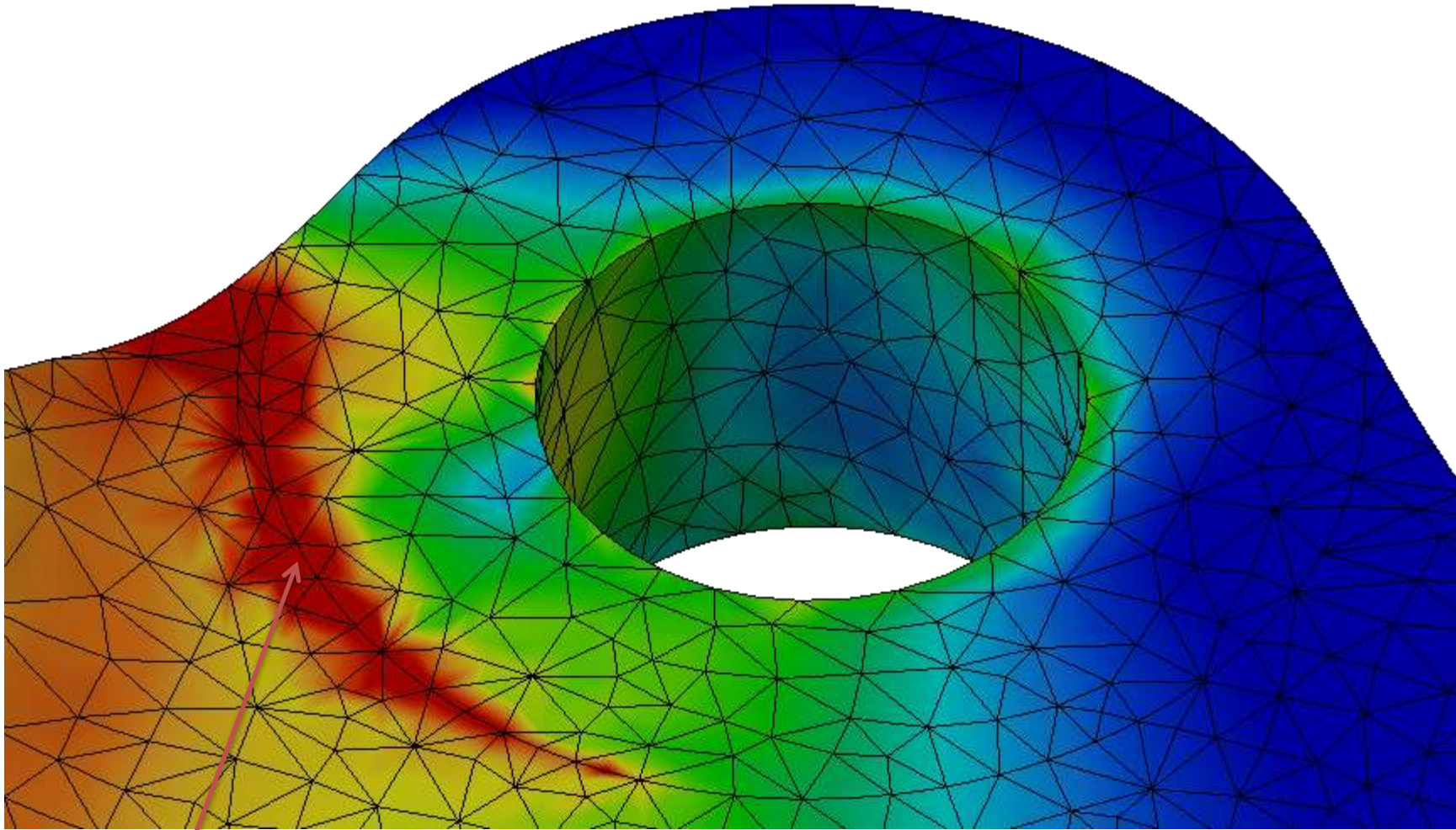

Spannungsspitzen durch
Contact Part

Gefährdeter Querschnitt

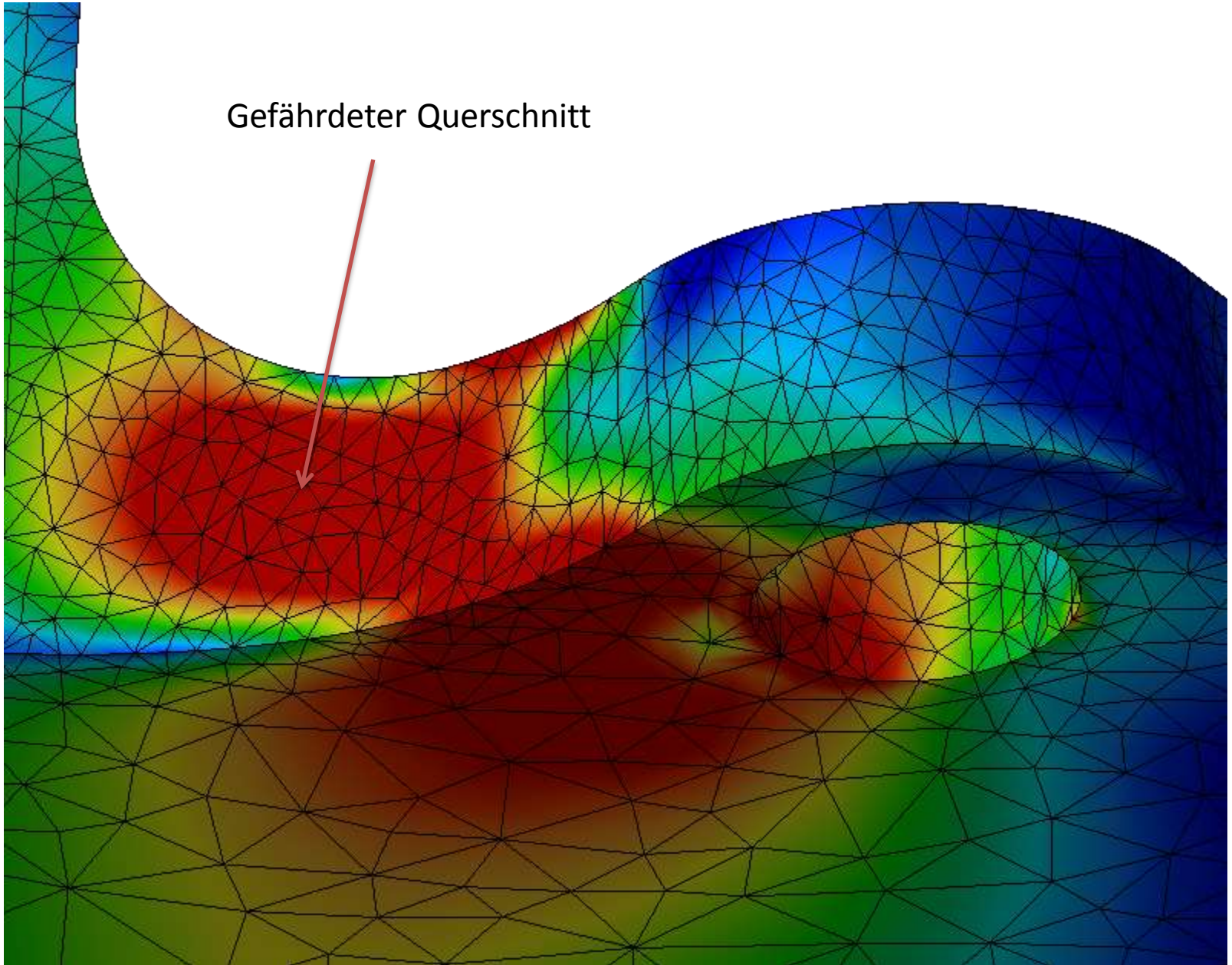

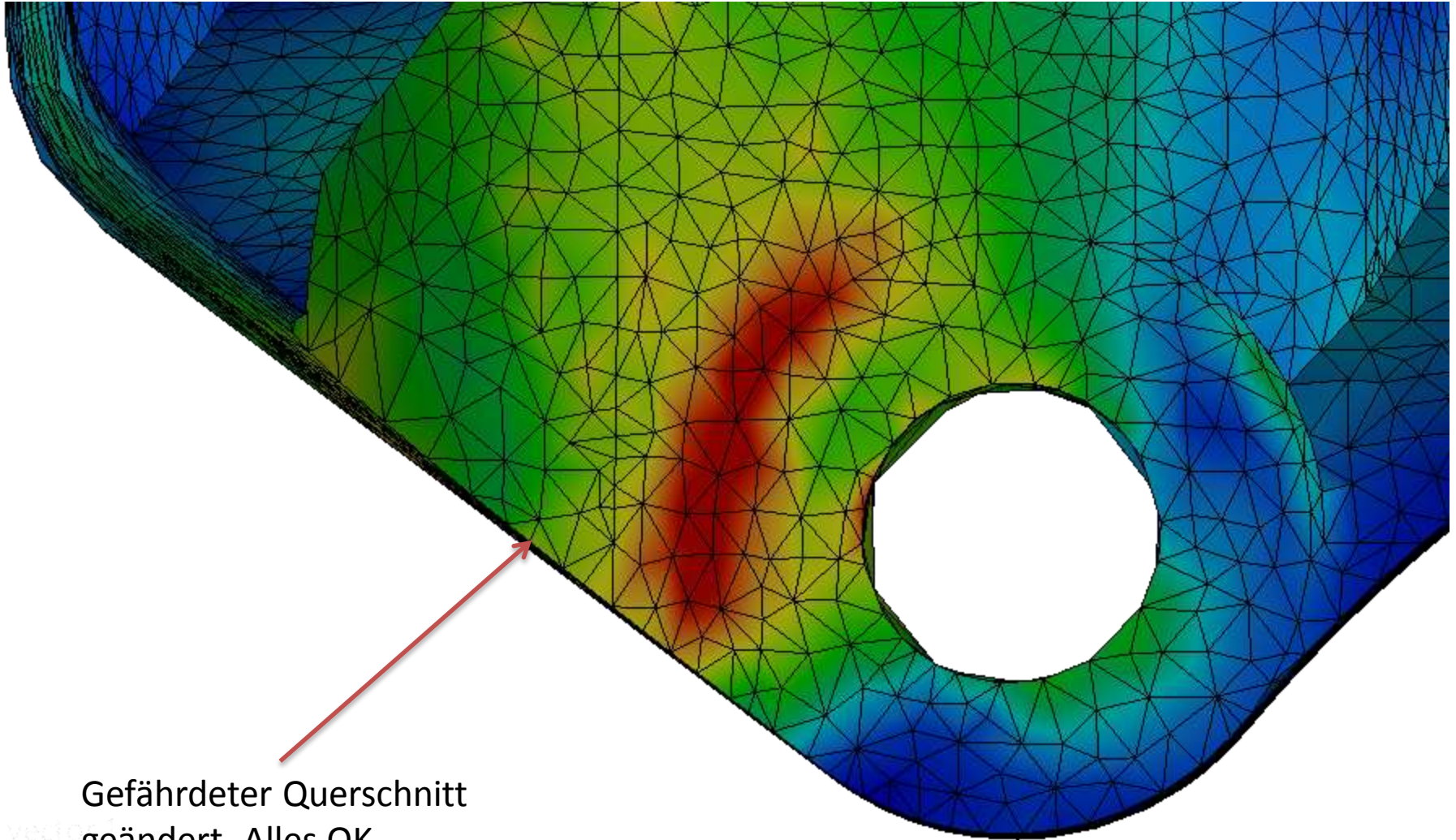

Gefährdeter Querschnitt
geändert. Alles OK.