

V (2:1)

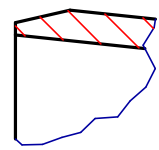

W (2:1)

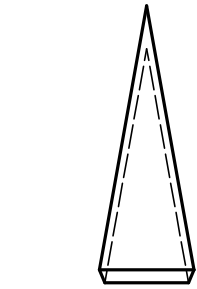

17 pieces

6,319 E+003 mm³

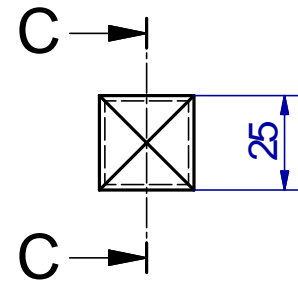

GC

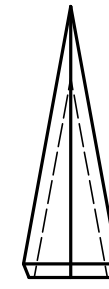

8 pieces

4,164 E+003 mm³

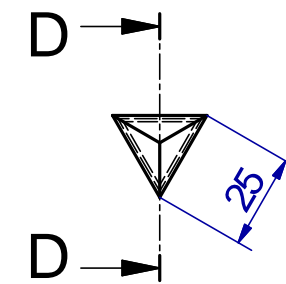

D-D

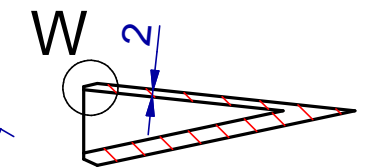

1 piece

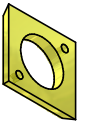

1,185 E+003 mm³

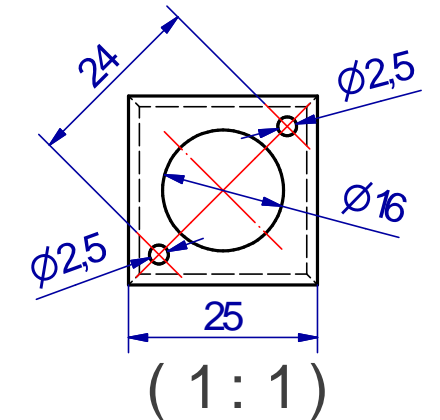
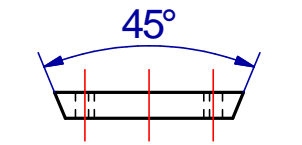

(1:1)

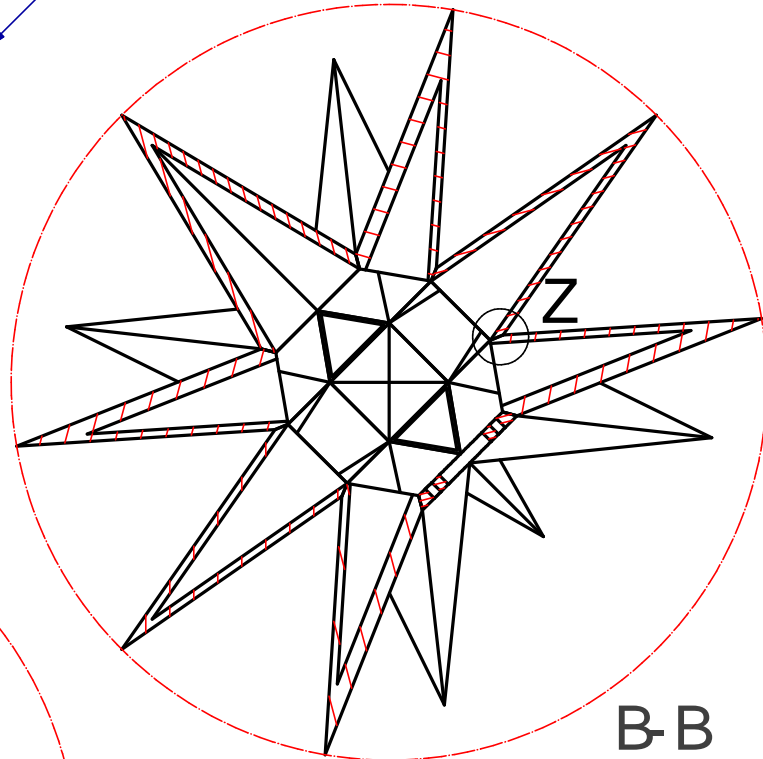

B-B

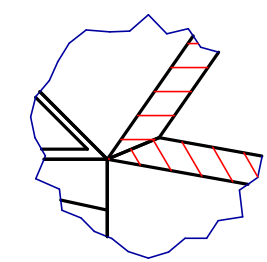

X (2:1)

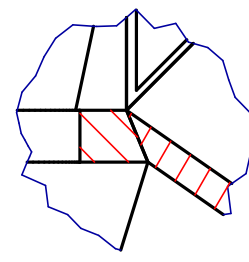

Y (2:1)

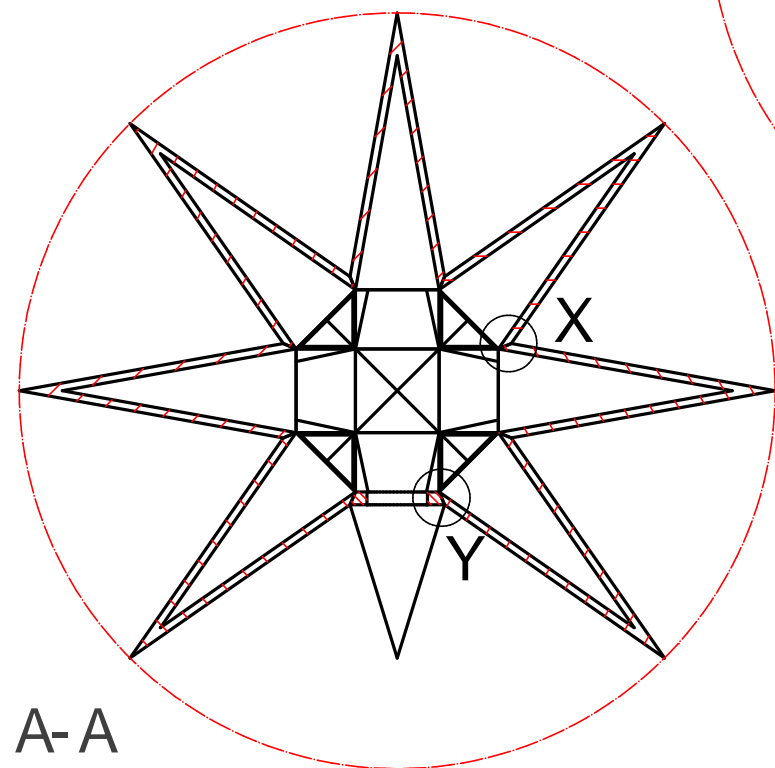

A-A

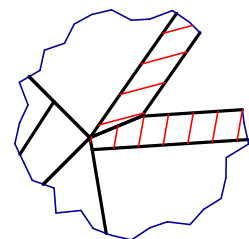

Z (2:1)

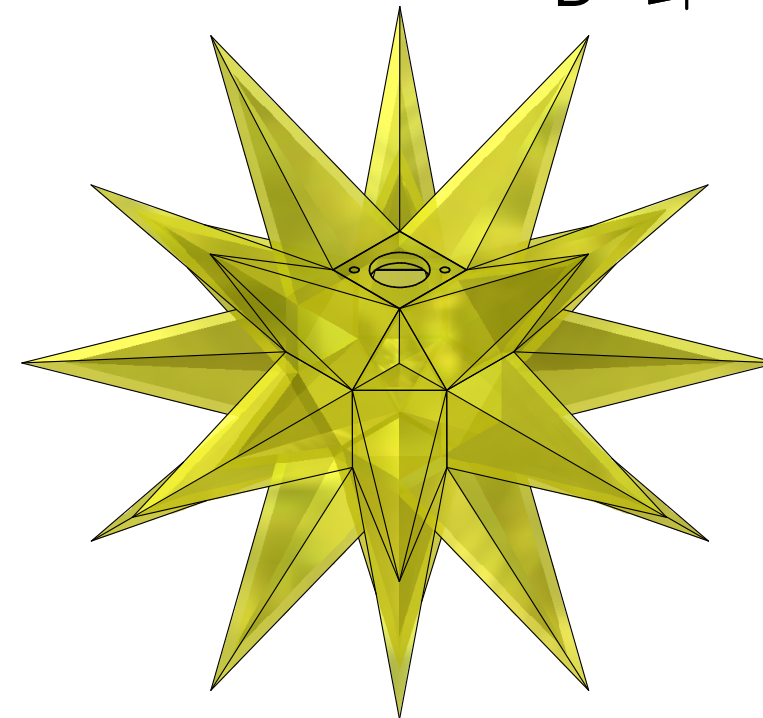

Volume: 1,419E+005mm³

First angle projection.
All dimensions in mm.

Material:	Shrinkage (est.): Length: Across:		
Surface treatment:	Not indicated Draft: Fillets:		
Inventor NG World Cup Original model by Michael Puschner			
Heat treatment:	Scale: 1:2 (1:1) (2:1)	Tolerances acc. to standard:	Rev. No.: Signature / date:
 www.ambu.com		Drawn: MP 03-10-29	Replacing: December03
		Appr.:	

This document was created with Win2PDF available at <http://www.daneprairie.com>.
The unregistered version of Win2PDF is for evaluation or non-commercial use only.